

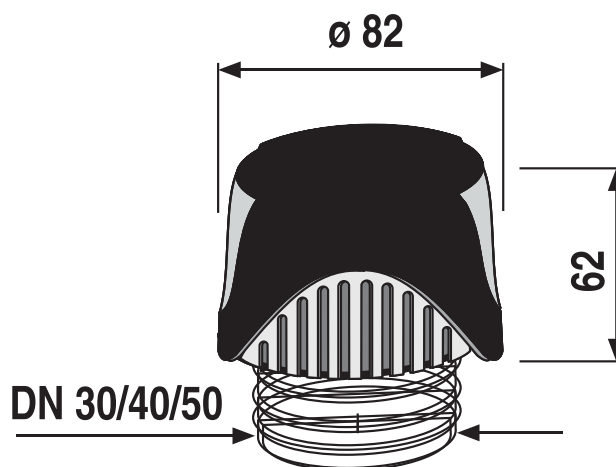

11A20000099

SANIT ventilair Air adm.valve DN 30-50



Articlenumber

11.A20.00..0099

product description

ventilair air-admittance valve suitable for DN 30/40/50
 type-tested and monitored in accordance with DIN EN 12380
 by TÜV Rheinland LGA Products GmbH, type class A I, volume
 flow 8 l/s, temperature range -20degC to +60degC, with
 polystyrene frost protection cover, with rubber connector for the
 dimensions stated